



INSTALLATION INSTRUCTIONS



www.bandbmolders.com

58471 Fir Road
Mishawaka, IN 46544
Phone: 574-259-7838
Fax: 574-259-7939



INSTALLATION INSTRUCTIONS

Items Included in System:



Polar White Part #'s

- 301-041-00001
- 301-041-00002
- 301-041-00003
- 301-041-00004

**Atmospheric Vacuum
Breaker/Check Valve**
Part #501-009-00002



In-Line Check Valve
Part #501-006-00006



Label
Part #103-002-00014

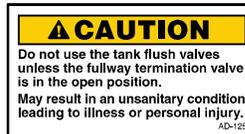

Spin Weld - Spray Head
Part #201-009-00001



OR

ABS Tank - Spray Head
Part #501-006-00006





INSTALLATION INSTRUCTIONS



Improper installation, operation or servicing this product will result in equipment damage & personal injury. This product should be installed & serviced by qualified technical personnel who have an in-depth knowledge of the construction process and potential hazards of this type of system.

- All B&B installed fittings are torqued to factory settings. Loosening or tightening these connections will result in potential leakage or damage voiding warranty consideration.
- All plumbing connections made to this product during installation should be hand tight plus ¼ turn. **DO NOT** over-tighten!!
- **DO NOT** "operate" equipment at power levels other than what is specified on equipment serial tag & data plate.
- Make sure tank fittings for black water tank flushing (ABS Tank & Rotomolded) are installed per instructions to avoid potential damage.
- **DO NOT** install panel with plumbing in a binding condition. Plumbing must have necessary room to move freely when panel is secured to mounting substrate.
- Double check ALL factory installed swivel fittings to hand tight plus ¼ turn due to potential loosening.
- OEM Manufacturer to provide user instructions clearly advising proper winterizing techniques. Damage to system due to incorrect winterizing techniques voids all warranty consideration.
- B&B Molders is not responsible for damage caused to other products connected to this system. It is the O.E.M. Manufacturer's responsibility to ensure plumbing is run to correct locations.
- Proper venting of freshwater holding tank is responsibility of RV manufacturer. (See B&B Power Vent for safe venting options.) Under sized vents may result in serious damage.
- Special rules apply for any warranty claim or submission. Please contact B&B Molders for further information.
- Do not use countersink headed screws due to potential cracking. Use only #8 pan headed screws.
- Nautilus System is designed for compartment use only and should not be used for exterior applications where exposure to exterior elements exists.
- System must be installed in a clean environment at O.E.M. free of dust and debris. Foreign contaminants have been proven to create leakage conditions.
- **Optional:** If this product comes equipped with a hot/cold faucet, make sure hot and cold are connected correctly. All plumbing connections made to this product during installation should be hand tight plus ¼ turn.

Tank Flush

- **DO NOT** over-tighten swivel fitting to threaded water inlet connection. Over-tightening may result in stress cracking to plastic threads.
- **DO NOT** plumb Atmospheric Vacuum Breaker/Check Valve (Vac/Check) in a binding condition that puts stress on part. Plumbing should be securely fastened to permanent structure.
- B&B strongly recommends installing Vac/Check within 6' – 8' of water inlet due to low pressure conditions.
- Vac/Check must be installed in an easily accessible location to end user.
- Vac/Check assembly must be plumbed in proper direction of flow & orientation.
- Working pressure per ASSE #1001 is 125 psi but **NOT LESS THAN** 8 psi.
- Spin weld fitting/sprayer must be installed according to Standard Plastic Welding Guidelines.

IMPORTANT: FAILURE TO FOLLOW THESE INSTRUCTIONS FOR INSTALLATION OF OUR PRODUCT WILL FORFEIT ANY WARRANTY CONSIDERATION.





INSTALLATION INSTRUCTIONS

IMPORTANT!!

NEVER push check valve on "CITY WATER" connection with pressure in line. This **WILL** cause irreparable damage to the check valve function.

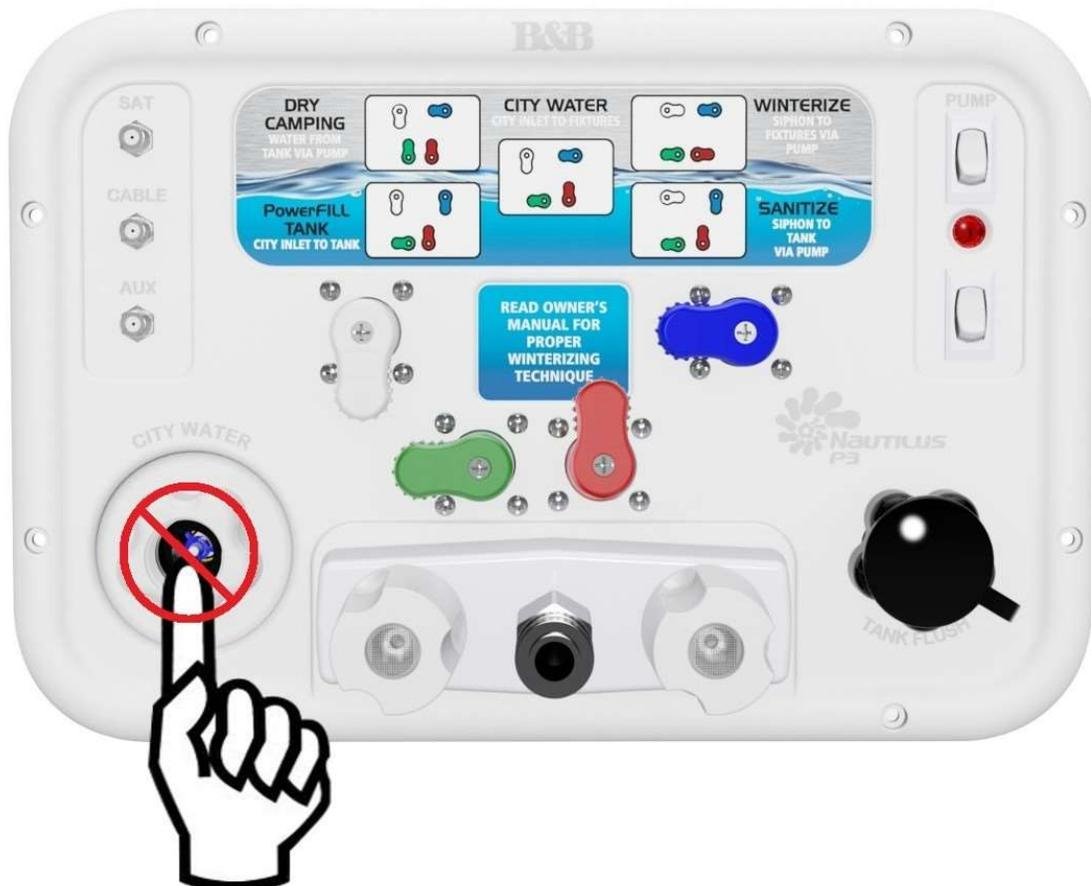

58471 Fir Road, Mishawaka, IN 46544
Phone: (574) 259-7838 Fax: (574) 259-7939
www.bandbmolders.com



INSTALLATION INSTRUCTIONS

Nautilus P3 Handle Position and Valve Routing Information

WHITE HANDLE: Receives water from water inlet on front of panel

Sideways - water goes to pump inlet



Down – water goes into blue handled diverter



BLUE HANDLE: Receives water from the white handle valve/water inlet on front of panel

Sideways - water goes to fixtures (cold)



Down – water will go to or come from fresh water tank



GREEN HANDLE: Is an on/off flow through valve that feeds pump from fresh water tank

Sideways - water will not flow through valve



Up – water will go to or come from fresh water tank



RED HANDLE: Receives water from cold water supply line

Sideways - water goes to hot water fixtures without going through hot water heater



Up – water goes to hot water heater





INSTALLATION INSTRUCTIONS

CONDENSED INSTRUCTIONS FOR QUICK REFERENCE

1. Cut a 13½ x 8½ opening in substrate material and feed necessary connections through opening..
2. Connect **(PUMP INLET)** harness **A** to back of Nautilus Panel.
3. Connect **(FRESH TANK)** harness **B** to back of Nautilus Panel.
4. Connect **(PRESSURE TO PUMP)** harness **C** to back of Nautilus Panel
5. Connect **(WATER INLET)** harness **D** to back of Nautilus Panel.
 - a. *WITH FILTER*: Connect **(WATER INLET)** at bottom of panel to **(FILTER IN)** and connect **(FILTER OUT)** to **(WATER INLET)** at top of panel.
 - b. *WITHOUT FILTER*: Connect **(WATER INLET)** at bottom of panel to **(WATER INLET)** at top of panel.
6. Connect **(HOT H2O LINE)** harness **E** to back of Nautilus Panel.
7. Connect **(H2O HEATER)** harness **F** to back of Nautilus Panel
8. Connect **(COLD H2O LINE)** harness **G** to back of Nautilus Panel.
9. Connect plumbing line running from **(TANK FLUSH)** **H** to bottom of listed **(VAC/CHK)**.
10. Connect necessary coaxial cable(s) to appropriate connection identified on top left panel and hand tighten.
11. Connect power service to terminals on back of pump switch, located on top right panel. Make sure wiring connection is routed correctly for two switch operation.
12. Secure panel to substrate material using (8) #8 self-tapping, pan-head operation.

****Connections shall be hand tight + ¼ turn. Do NOT over tighten as stress cracking may result**





INSTALLATION INSTRUCTIONS

FULL HARNESS ASSEMBLY



HARNESS INFORMATION:

- A** : Pump Inlet
- B** : To Fresh Tank
- C** : Pressure from Pump
- D** : Water Inlet
- E** : Hot H2O Line
- F** : To H2O Heater
- G** : Cold H2O Line
- H** : Tank Flush

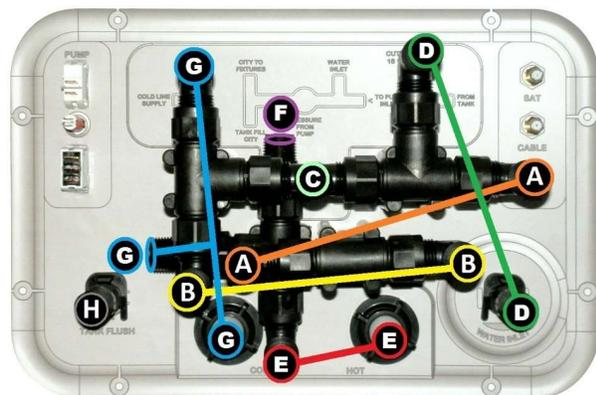



INSTALLATION INSTRUCTIONS

A PUMP INLET (PLUMBING HARNESS)

Items Needed:

- (2) 90° Swivel Fittings
- (1) Inline Tee
- (4) Oetiker Clamps
- 1/2" Pex Tubing Lines:
 - ♦ (2) 2 3/8"



To connect pump inlet harness, screw swivel fittings onto diverter valves **A** (TO PUMP INLET) as illustrated. This line will run directly to "IN" side of water pump.

**Connections shall be hand tight + 1/4 turn.
Do NOT over tighten as stress cracking may result.**





INSTALLATION INSTRUCTIONS

B TO FRESH TANK (PLUMBING HARNESS)

Items Needed:

- (2) 90° Swivel Fittings
- (1) Inline Tee
- (4) Oetiker Clamps
- ½" Pex Tubing Lines:
 - ♦(2) 2 1/16"

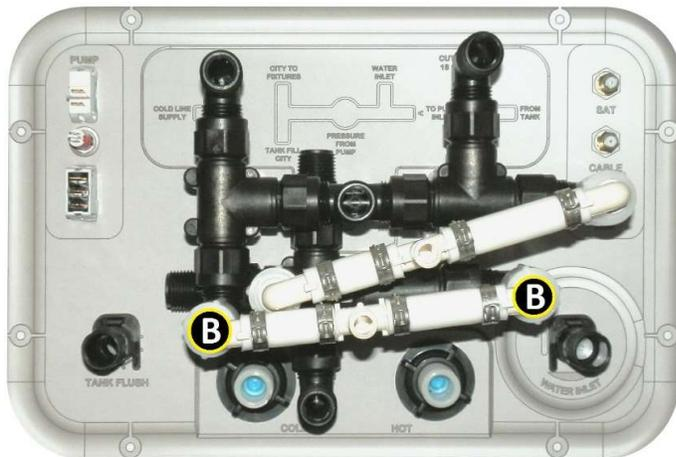

To connect fresh tank plumbing harness, screw swivel fittings onto diverter valves **B** (TANK FILL CITY & FROM TANK) as illustrated. This line will run directly to bottom of fresh water tank.

**Connections shall be hand tight + ¼ turn.
Do NOT over tighten as stress cracking may result.**





INSTALLATION INSTRUCTIONS

Ⓒ PRESSURE FROM PUMP

Items Needed:

- (1) Straight Swivel Fittings



To connect plumbing line coming from pump, screw swivel fitting onto diverter valve **Ⓒ (PRESSURE FROM PUMP)** as illustrated. This line will run directly to “OUT” side of water pump.

**Connections shall be hand tight + ¼ turn.
Do NOT over tighten as stress cracking may result.**





INSTALLATION INSTRUCTIONS

D WATER INLET WITHOUT FILTER (PLUMBING HARNESS)

Items Needed:

- (2) 90° Inline Elbows
- (2) Straight Swivel Fittings
- (6) Oetiker Clamps
- 1/2" Pex Tubing Lines:
 - ◆ (1) 1 5/8", (1) 3", (1) 5 3/8"

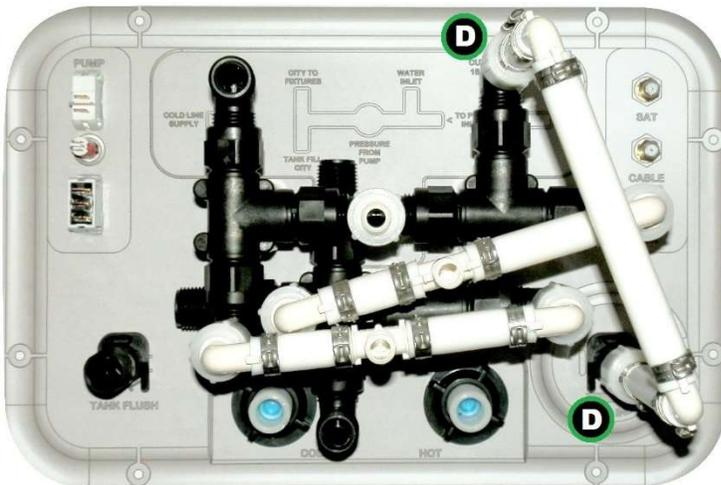
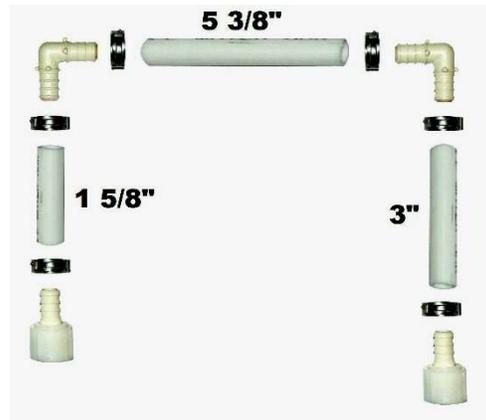

Pictured: WATER INLET without filter connection.

UNITS WITHOUT FILTER

To connect water inlet harness, screw swivel fittings onto diverter valves **D** (WATER INLET) as illustrated.

UNITS WITH FILTER

To connect line running to (FILTER IN), screw swivel fitting onto **D** (WATER INLET) at bottom of panel. To connect line running to "FILTER OUT," screw swivel fitting onto **D** (WATER INLET) at top of panel.

**Connections shall be hand tight + 1/4 turn.
Do NOT over tighten as stress cracking may result.**





INSTALLATION INSTRUCTIONS

E HOT H2O LINE (PLUMBING HARNESS)

Items Needed:

- (1) 90° Inline Elbows
- (1) Inline Tee
- (2) Straight Swivel Fittings
- (6) Oetiker Clamps
- 1/2" Pex Tubing Lines:
 - ♦(2) 1½", (1) 2"

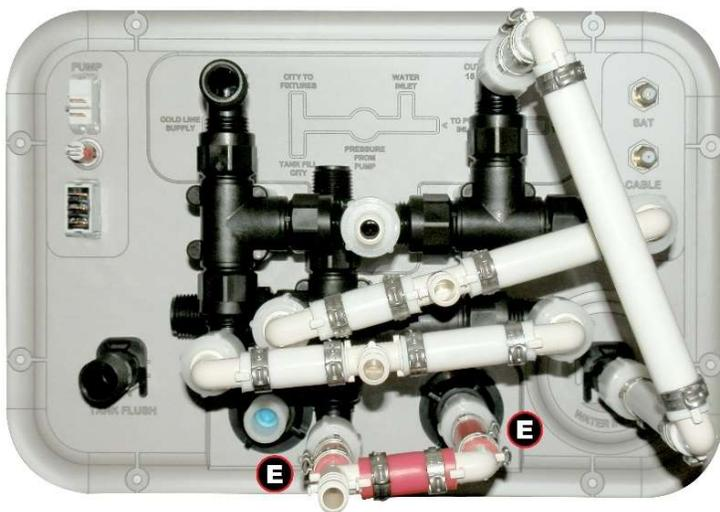
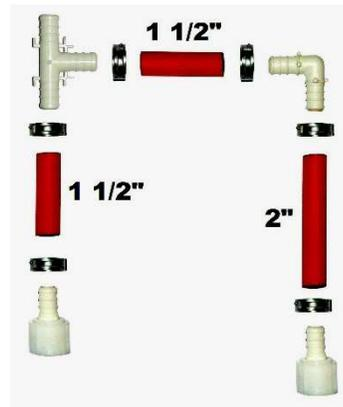

To connect hot water line plumbing harness, screw swivel fittings onto diverter valves **E** (**HOT & HOT H2O LINE**). This line will connect to the hot water line feeding fixtures.

- **HOT** on Shower Faucet
- **HOT H2O LINE**

**Connections shall be hand tight + ¼ turn.
Do NOT over tighten as stress cracking may result.**





INSTALLATION INSTRUCTIONS

F TO H2O HEATER

Items Needed:

- (1) 90° Swivel Fitting

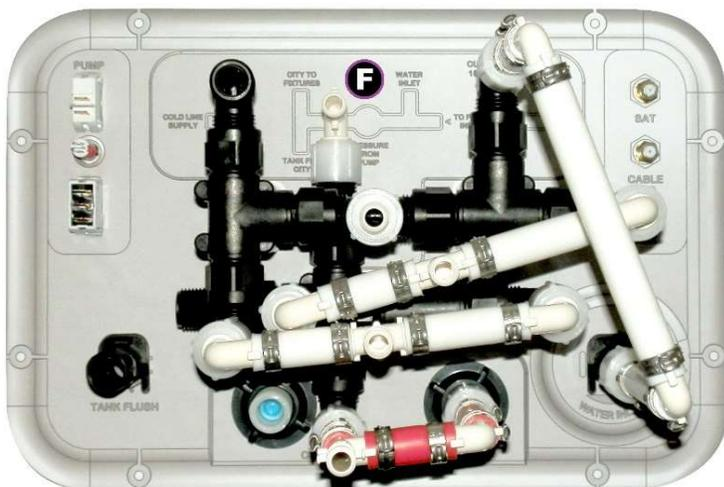

To connect plumbing line running to hot water heater, screw swivel fitting onto diverter valve **F (TO H2O HEATER)** as illustrated. This line will run directly to "IN" on hot water heater.

**Connections shall be hand tight + ¼ turn.
Do NOT over tighten as stress cracking may result.**





INSTALLATION INSTRUCTIONS

G COLD H2O LINE (PLUMBING HARNESS)

Items Needed:

- (2) 90° Inline Elbows
- (2) Inline Tees
- (2) Straight Swivel Fitting
- (1) 90° Swivel Fitting
- (12) Oetiker Clamps
- ½ Pex Tubing Lines
 - ♦ (1) 4", (1) 3½", (1) 2⅞, (1) 1½", (1) 1⅝", (1) 1½"

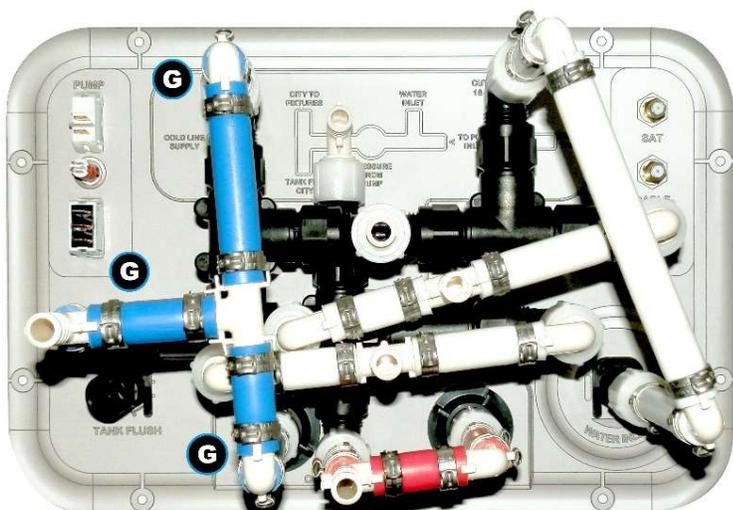
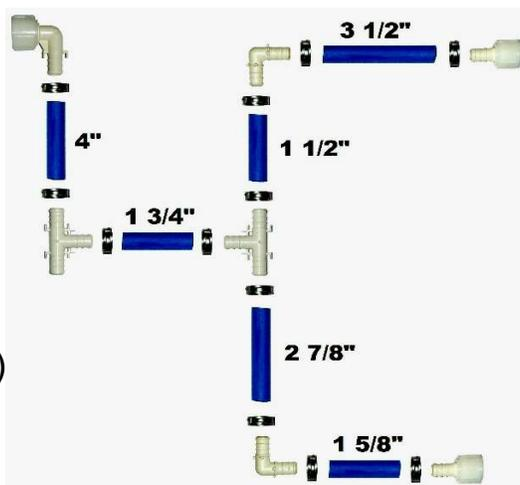

To connect the cold line plumbing harness, screw swivel fittings onto diverter valves **G** (COLD, COLD LINE SUPPLY, & CITY TO FIXTURES) as illustrated. This line will connect to the cold water line feeding fixtures.

**Connections shall be hand tight + ¼ turn.
Do NOT over tighten as stress cracking may result.**

